

This article was downloaded by:

On: 24 January 2011

Access details: *Access Details: Free Access*

Publisher *Taylor & Francis*

Informa Ltd Registered in England and Wales Registered Number: 1072954 Registered office: Mortimer House, 37-41 Mortimer Street, London W1T 3JH, UK



Journal of Macromolecular Science, Part A

Publication details, including instructions for authors and subscription information:

<http://www.informaworld.com/smpp/title~content=t713597274>

PHOTOPOLYMERS: SYNTHESIS AND CHARACTERIZATION OF POLY(4-CINNA-MOYLPHENYL METHACRYLATE) WITH GLYCIDYL METHACRYLATE

K. Subramanian^a; S. Nanjundan^a; A. V. Rami Reddy^b

^a Department of Chemistry, Anna University, Chennai, India ^b R. O. Division, Central Salt and Marine Chemicals Research Institute, Bhavnagar, India

Online publication date: 26 September 2000

To cite this Article Subramanian, K. , Nanjundan, S. and Reddy, A. V. Rami(2000) 'PHOTOPOLYMERS: SYNTHESIS AND CHARACTERIZATION OF POLY(4-CINNA-MOYLPHENYL METHACRYLATE) WITH GLYCIDYL METHACRYLATE', *Journal of Macromolecular Science, Part A*, 37: 10, 1211 – 1225

To link to this Article: DOI: 10.1081/MA-100101150

URL: <http://dx.doi.org/10.1081/MA-100101150>

PLEASE SCROLL DOWN FOR ARTICLE

Full terms and conditions of use: <http://www.informaworld.com/terms-and-conditions-of-access.pdf>

This article may be used for research, teaching and private study purposes. Any substantial or systematic reproduction, re-distribution, re-selling, loan or sub-licensing, systematic supply or distribution in any form to anyone is expressly forbidden.

The publisher does not give any warranty express or implied or make any representation that the contents will be complete or accurate or up to date. The accuracy of any instructions, formulae and drug doses should be independently verified with primary sources. The publisher shall not be liable for any loss, actions, claims, proceedings, demand or costs or damages whatsoever or howsoever caused arising directly or indirectly in connection with or arising out of the use of this material.

PHOTOPOLYMERS: SYNTHESIS AND CHARACTERIZATION OF POLY(4-CINNAMOYLPHENYL METHACRYLATE) WITH GLYCIDYL METHACRYLATE

K. Subramanian* and **S. Nanjundan**

Department of Chemistry
Anna University
Chennai 600 025, India

A. V. Rami Reddy

R. O. Division
Central Salt and Marine Chemicals Research Institute
Bhavnagar 364 002, India

Key Words: 4-Cinnamoylphenyl Methacrylate, Glycidyl Methacrylate, Copolymer, Reactivity Ratio, $^1\text{H-NMR}$, Photocrosslinking, Photoconversion

ABSTRACT

Copolymers of 4-cinnamoylphenyl methacrylate (CPMA) with glycidyl methacrylate were synthesized in methyl ethyl ketone solution using benzoyl peroxide as initiator at $70 \pm 1^\circ\text{C}$. They were characterized by UV, IR, $^1\text{H-NMR}$, and $^{13}\text{C-NMR}$ spectra. Their compositions were determined by $^1\text{H-NMR}$ technique. The monomer reactivity ratios were determined by the Fineman-Ross and Kelen-Tüdös methods. The molecular weights (\overline{M}_w and \overline{M}_n) of the polymers were determined by GPC technique. Thermogravimetric analysis of the copolymers were carried out in air. The T_g of the polymers were determined by differential scanning

*Author to whom all correspondence should be addressed.

calorimetry. The photocrosslinking properties of the homo and copolymers were also discussed.

INTRODUCTION

Many polymers with reactive functional groups are now being synthesized, tested and used not only for their macromolecular properties, but also for the properties of functional group. These groups provide an approach to a subsequent modification of the polymer for specific end applications [1]. Polymers with photosensitive groups find application in printing materials [2], micro-lithography [3], energy exchange materials [4], etc. Polymers having α,β -unsaturated carbonyl groups either in the backbone or in pendant groups undergo crosslinking upon irradiation, and such polymers are regarded as negative type photoresists. Crosslinking with u.v. light is an excellent method to make articles having thick cross sections, with or without reinforcement, without large heat built-up in the interior, which would damage the plastic [5]. Photosensitive polymers with a combination of properties such as high photosensitivity, good thermal stability, and good solubility are essential for practical use as photoresists. Polymers with a pendant photofunctional group, such as cinnamoyl esters of poly(vinyl alcohol) and poly(2-hydroxy ethyl methacrylate) [6-9], poly (2-vinyloxyethyl cinnamate) [10] and many other polymer systems [11-16] have been prepared and tested for photosensitivity. We have already reported the synthesis and characterization of poly(4-cinnamoylphenyl methacrylate) [17].

In the present paper, the synthesis, characterization, thermal stability and photosensitive properties of copolymers of 4-cinnamoylphenyl methacrylate (CPMA) with glycidyl methacrylate are reported.

EXPERIMENTAL

Glycidyl methacrylate (GMA) was freed from inhibitor by vacuum distillation. Benzoyl peroxide (BPO) was recrystallized from a chloroform-methanol (1:1) mixture. All the solvents were purified by distillation prior to use. 4-Cinnamoylphenyl methacrylate (CPMA) was synthesized as reported [17] by reacting 4-cinnamoylphenol (0.12 mol) with methacryloyl chloride (0.12 mol) at 0 to -5°C in the presence of triethylamine (0.12 mol) in methyl ethyl ketone solution. Methacryloyl chloride was prepared by reacting methacrylic acid (1 mol) with benzoyl chloride (3 mol) [18].

Copolymerization

Copolymers of CPMA and glycidyl methacrylate (GMA) with six different compositions (Table 1) were prepared in methyl ethyl ketone (MEK) using benzoyl peroxide as initiator at $70 \pm 1^\circ\text{C}$. Appropriate amounts of GMA, CPMA, BPO and MEK were mixed in a reaction tube and purged with nitrogen for 20 minutes. After the sealed tubes had been kept at $70 \pm 1^\circ\text{C}$ for the required time (≈ 2 hours) the contents were poured into excess of methanol. The conversions were restricted to less than 10% in order to make use of copolymer equation. The polymers were purified by repeated precipitation by methanol from the solution of polymer in chloroform and finally dried under vacuum at 60°C .

Measurements

Ultraviolet spectra of the polymers were recorded with a Hitachi UV-2000 spectrophotometer. Infrared spectra were obtained with a Hitachi 270-

TABLE 1. Composition and Molecular Weight Data of Free Radical Copolymerization of CPMA with Glycidyl Methacrylate

Sample No.	M_1	Conversion (%)	C	m_1	$(\bar{M}_w \times 10^{-4})$	$(\bar{M}_n \times 10^{-4})$	\bar{M}_w / \bar{M}_n
1.	0.10	8.04	0.1	0.18	2.77	1.45	1.91
			5				
2.	0.20	8.25	0.2	0.28	2.61	1.45	1.80
			2				
3.	0.35	7.60	0.3	0.49	3.79	2.05	1.84
			4				
4.	0.50	10.04	0.4	0.68	3.26	1.82	1.79
			3				
5.	0.65	9.06	0.4	0.81	4.09	2.16	1.89
			9				
6.	0.85	7.08	0.5	0.92	3.65	2.17	1.68
			3				

M_1 is the mole fractions of CPMA in the feed.

m_1 mole fraction of CPMA in copolymer.

C is the ratio of the integrated intensities of aromatic protons to that of total protons in the $^1\text{H-NMR}$ spectra of copolymers.

50 IR spectrophotometer on solid samples as KBr pellets. NMR spectra were obtained with JEOL JNX-100 FT NMR spectrometer. CDCl_3 and CHCl_3 were used as solvents for taking ^1H and ^{13}C -NMR spectra and TMS was used as the internal standard. Mettler TA 3000 thermal analyzer was used for thermogravimetric analysis. TG traces were recorded on 10 mg samples in air at a heating rate of $15^\circ\text{C min}^{-1}$. The glass transition temperatures of the copolymers were determined by differential scanning calorimetry with a Dupont 900 thermal analyser at a heating rate of $15^\circ\text{C min}^{-1}$ in air. Molecular weights (\bar{M}_w and \bar{M}_n) of the polymers were determined using Waters 501 gel permeation chromatograph equipped with a RI detector and calibrated with polystyrene standards.

Photoreactive Measurements

Thin films of polymer from 2% solution in chloroform were made on quartz plate and irradiated at room temperatures in air with a high pressure Hg lamp (Toshiba SHL-100 UV, 75W) for different time intervals. The quartz plate was kept at a distance of 10cm from the mercury lamp. The photoreactivities of the copolymers were measured by recording the UV spectrum of the polymer film at different time intervals immediately after irradiating the polymer film with UV light. The rate of photocrosslinking was followed by the decrease in UV absorption intensity at 311 nm using the following equation:

$$\text{Rate of conversion (\%)} = \frac{A_0 - A_T}{A_0 - A_\infty} \times 100$$

where A_0 , A_T and A_∞ are absorption intensities after irradiation time $t = 0$, $t = T$ and $t = \infty$, respectively.

RESULTS AND DISCUSSION

The copolymerization of CPMA and GMA in MEK solution was studied in a wide composition range with mole fractions of CPMA ranging from 0.10 to 0.90 in the monomer feed. The reaction time was selected so as to give conversions less than 10% in order to satisfy the differential copolymerization equation [19]. The data on the compositions of the feed and copolymers are presented in Table 1. The monomeric units in the copolymer are shown in Scheme 1.

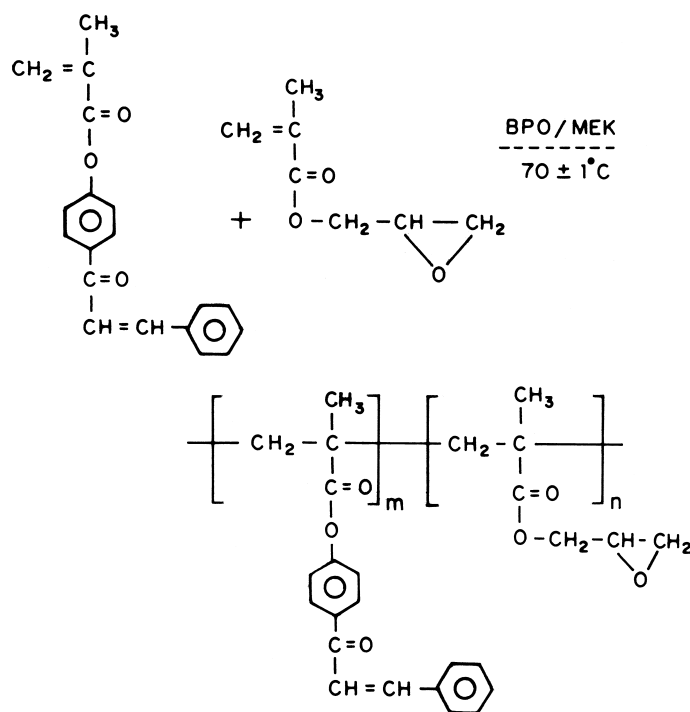

Scheme 1.

Characterization

The solubilities of the copolymers in various organic solvents were tested since the solubility is one of the important requirements for a photosensitive polymer. The copolymers were soluble in polar aprotic solvents, namely dimethylformamide, N-methyl-2-pyrrolidone, dimethylacetamide, dimethylsulfoxide, tetrahydrofuran, etc. and chlorinated solvents such as chloroform and methylene chloride. They were insoluble in hydrocarbons (eg. benzene, toluene, xylenes), and hydroxy group containing solvents such as methanol, ethanol and 2-propanol.

The UV spectra of copolymers show an absorption maximum at about 311 nm due to the pendant α,β -unsaturated ketone (4-cinnamoylphenyl) group of CPMA units.

The IR spectra of the copolymers (Figure 1) show strong absorptions at 1750 and 1680 cm^{-1} due to $>\text{C}=\text{O}$ stretching of ester and ketone groups, respectively. A strong band at about 1610 cm^{-1} corresponds to the pendant olefin group

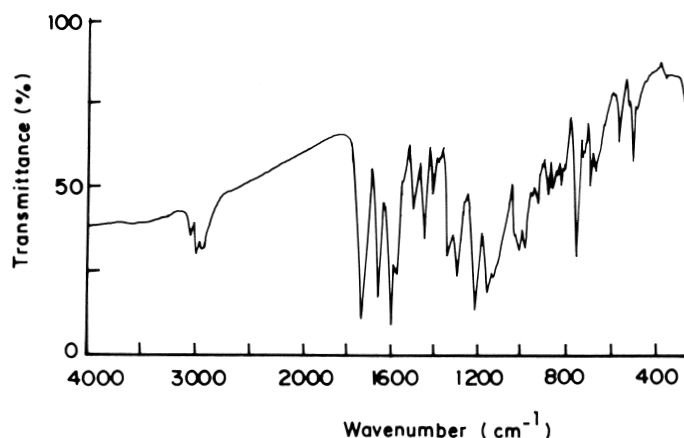

Figure 1. Infrared Spectrum of Poly (CPMA-Co-GMA).

which is flanked by a ketone and a phenyl group in CPMA unit. The aromatic $>C=C<$ stretchings are observed at 1510 cm^{-1} . Peaks at 3100 cm^{-1} is due to aromatic C-H stretching vibrations. The absorptions due to epoxy group of the GMA unit appears at 990 and 940 cm^{-1} . Peaks at $770\text{--}750\text{ cm}^{-1}$ may due to aromatic C-H out of plane bendings, and those at 1440 cm^{-1} may be assigned to CH_3 bending vibrations.

The ^1H NMR spectrum of poly (CPMA-co-GMA) is presented in Figure 2. The multiplet resonance signals at $8.06\text{--}7.23$ ppm correspond to the aromatic

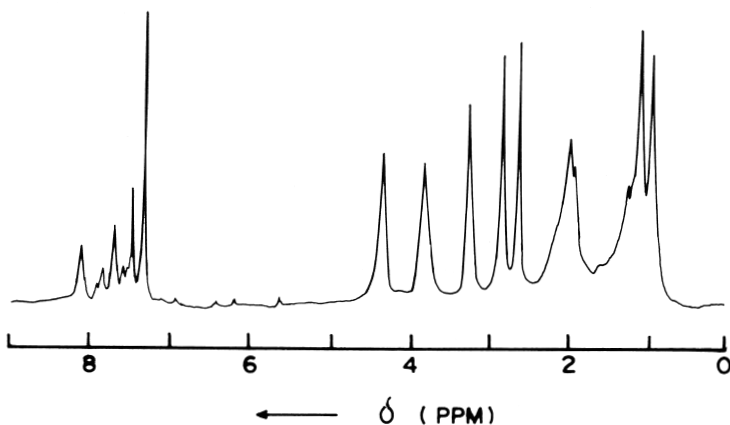

Figure 2. Proton NMR Spectrum of Poly (CPMA-Co-GMA).

protons of the CPMA unit. The resonance signals of the olefinic protons of the pendant chalcone moiety are observed at 6.38 and 5.84 ppm. Signals at 4.33 and 3.76 ppm are due to $-OCH_2-$ protons of the ester group and the epoxy group respectively. The signal at 3.24 ppm corresponds to the ring methyne protons of GMA unit. The backbone $-CH_2$ proton signals of the two comonomer units are observed at 2.76-1.85 ppm. A group of signals at 1.26-0.88 ppm originate due to α -methyl protons of CPMA and GMA units.

The proton decoupled ^{13}C -NMR spectrum of poly (CPMA-co-GMA) is shown in Figure 3. Chemical shift assignments were made from the off-resonance decoupled spectra of the copolymers. Resonance signals at 190.2 ppm corresponds to carbonyl carbon of keto group present in the pendant cinnamoyl group in CPMA units. The ester carbonyl carbon resonance is observed at 173.3 ppm. The signal due to carbon of the aromatic ring attached to the ester group shifts towards downfield and is observed at 154.4 ppm. Resonance signals at 145.0 ppm may be assigned to the olefinic carbon which is attached to the aromatic ring. The other aromatic carbons are observed at 136-121 ppm. The methylenoxy group flanked between the carbonyl group and the epoxy group, the epoxy ring methylene ($-CH_2$) and methyne ($-CH$) carbons of GMA show sig-

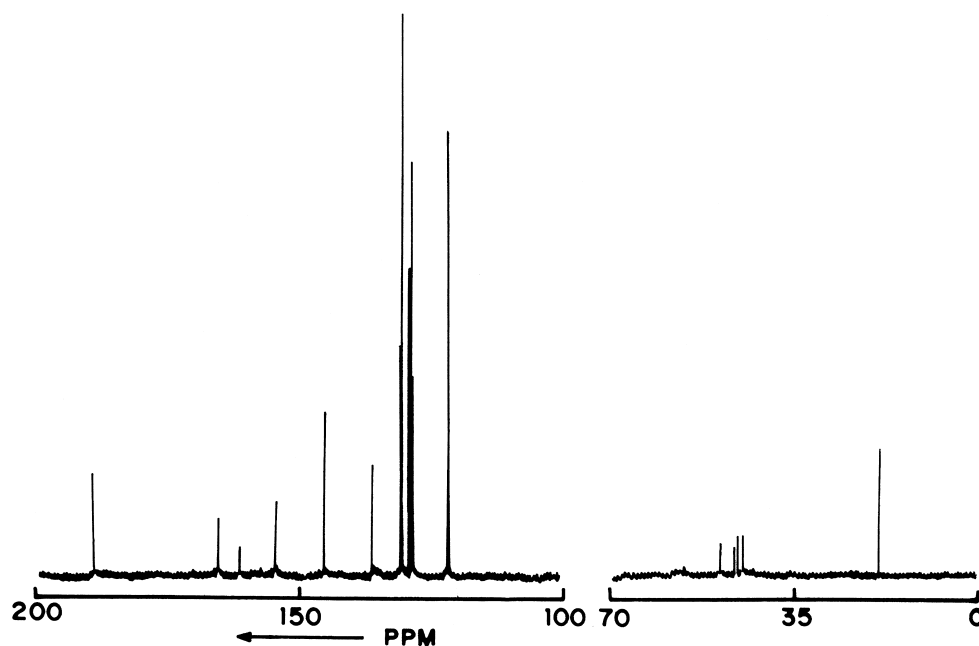

Figure 3. Proton Decoupled ^{13}C -NMR Spectrum of Copoly (CPMA-GMA).

nals at 65.5, 55.4, and 52.1 ppm respectively. The signals due to backbone methylene carbon and the ring methyne carbon in the GMA unit are observed at 46.4 and 44.8 ppm, respectively. The α -methyl group of GMA and CPMA shows resonance signals at 18.3 ppm.

Copolymer Composition

The chemical structure of copolymers may be represented as in Scheme 1. Copolymer compositions were determined by $^1\text{H-NMR}$ analysis. The assignment of the resonance peaks in the $^1\text{H-NMR}$ spectrum allows for the accurate evaluation of the content of both kind of monomeric units incorporated into the copolymer chains.

The following expression was derived to calculate the copolymer composition. Let m_1 be the mole fraction of CPMA and $1-m_1$ be that of GMA in the copolymer. There are 9 aromatic protons and 26 total protons (16H in CPMA and 10H in GMA). Hence,

$$\frac{9m_1}{16m_1 + 10(1-m_1)} = \frac{\text{Intensities of aromatic protons}}{\text{Intensities of total protons}} = C \quad (1)$$

on simplification it leads to

$$m_1 = \frac{10C}{9-6C} \quad (2)$$

From Equation 2, the mole fractions of CPMA in copolymers were determined by measuring the integrated peak heights of aromatic proton signals and that of the total proton signals of both the monomer units. Table 1 gives the values of C and the corresponding mole fractions of CPMA in the copolymers. The plot of (Figure 4) monomer feed composition versus copolymer composition shows that for all feed compositions the mole fraction of CPMA is more in copolymer than in the feed and the nature of curve indicates that the distribution of monomers in copolymers is statistical.

Reactivity Ratios

From the monomer feed ratios and the copolymer compositions, the reactivity ratios of CPMA and GMA were determined by the application of methods due to Fineman-Ross (F-R) [20] and Kelen-Tüdös (K-T) [21]. The val-

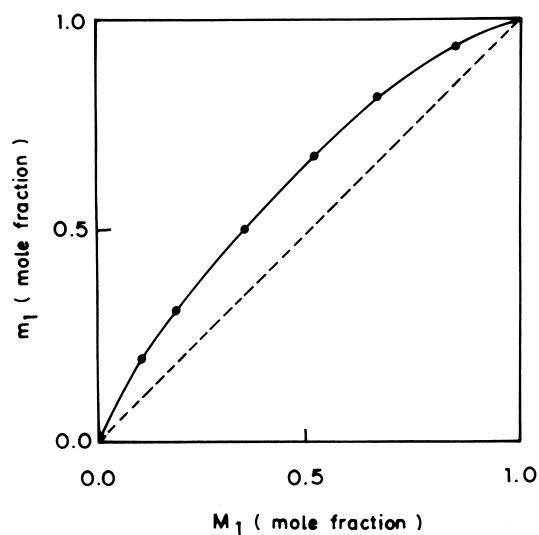

Figure 4. Composition Curve of Copolymers of CPMA with GMA.

ues from the F-R plot (Figure 5) and K-T plot (Figure 6) are presented in Table 2. The difference in the reactivity ratio values obtained by F-R and K-T methods is negligible. The reactivity ratio of CPMA ($r_1 = 2.32$) is greater than 1 and that of GMA ($r_2 = 0.56$) is less than 1. The reactivity of growing radicals with GMA

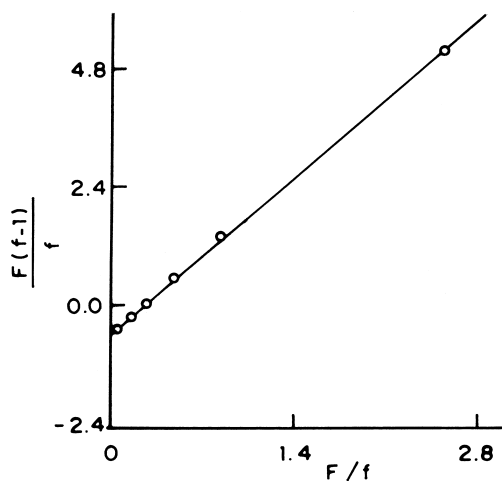

Figure 5. F-R plot for the Determination of Reactivity Ratios of CPMA-GMA Copolymer System.

unit, as measured by $1/r_2$ seems to be higher towards CPMA monomer than its own monomer. The r_1 and r_2 values strongly suggest that the copolymer chain contains more number of CPMA units and less number of GMA units than that in the feed.

Molecular Weights

The weight average (\bar{M}_w) and number average (\bar{M}_n) molecular weights and the polydispersity indexes (\bar{M}_w/\bar{M}_n) of poly (CPMA) and the copolymer samples are presented in Table 1. The polydispersity index for poly(CPMA) is 1.76 [17]. The theoretical values of (\bar{M}_w/\bar{M}_n) for polymers produced via radical recombination and disproportionation are 1.5 and 2.0, respectively [22]. The value of (\bar{M}_w/\bar{M}_n) in copolymerization is also known to depend on chain termination in the same way as in homopolymerization [23]. Hence, the polydispersity index values of these copolymers suggest a strong tendency for chain termination by disproportionation at higher mole fractions of GMA and recombination at higher mole fractions of CPMA in the feed.

Glass Transition Temperatures

The glass transition temperature (T_g) of copolymers were determined by DSC and the data are presented in Table 2. All the prepared copolymers show a single T_g , showing the absence of any mixture of homopolymers or the formation of block copolymer. The T_g of poly(CPMA) is 147°C. The T_g of poly(GMA) is 74°C [24]. The T_g of copolymers containing about 0.5 mole fraction of the CPMA monomer unit is higher by about 10-50°C compared to the T_g of poly (GMA). The initial increase in the T_g value of poly (GMA) due to the incorporation of the photomonomer upto 0.5 mole fraction is not much prominent compared to the increase observed when photomonomer incorporated into copoly-

TABLE 2. Copolymerization Parameters for the Free Radical Copolymerization of CPMA with GMA

Method	r_1	r_2	$r_1 r_2$	$1/r_1$	$1/r_2$
Fineman-Ross	2.36 ± 0.04	0.54 ± 0.02	1.27	0.42	1.85
Kelen-Tüdös	2.32 ± 0.05	0.56 ± 0.04	1.30	0.43	1.80
Average	2.34 ± 0.07	0.55 ± 0.06	1.29	0.43	1.83

r_1 and r_2 are the reactivity ratios for CPMA and GMA, respectively.

mer contained higher mole fraction of CPMA. The copolymer microstructure analysis [25] have shown that at higher mole fractions of GMA in the monomer feed the resultant copolymers contained longer sequences of GMA units which are separated by smaller sequence of 2-3 CPMA units. Similarly, at higher mole fractions of photomonomer in the feed exactly, an opposite behaviour has been observed. However, at mole fractions of 0.40-0.60 of either of the monomer in the feed the copolymers formed contained a sequence of 1-3 units of each monomer.

Thermogravimetric Analysis

The thermal stabilities of the copolymers was studied by thermogravimetric analysis in air and the data are presented in Table 3. A 10% weight loss of copolymers occurs at about 325°C. The copolymers undergo decomposition in two stages similar to poly (CPMA) which is a characteristic of thermo-oxidative

TABLE 3. Glass Transition Temperatures and TGA Data for CPMA-GMA Copolymers

m_1	$T_g(^{\circ}\text{C})$	DTR ($^{\circ}\text{C}$)		TWL ($^{\circ}\text{C}$)				
		Stage 1	Stage 2	10%	25%	50%	75%	90%
1.00	147	272-533 (76)	553-659 (19)	307	369	458	503	592
0.18	-	272-509 (89)	530-624 (10)	330	345	366	422	523
0.28	-	282-438 (70)	458-629 (28)	338	348	400	475	575
0.49	89	296-539 (66)	560-647 (32)	340	413	459	493	588
0.68	101	300-533 (58)	553-659 (41)	342	418	462	496	593
0.81	130	303-521 (46)	535-641 (51)	345	418	462	498	608
0.92	-	305-539 (36)	560-653 (62)	345	422	463	512	616

Figures in parenthesis indicate weight loss (%) during the temperature range stated.

m_1 : Mole fraction of CPMA in copolymer; T_g : glass transition temperature ($^{\circ}\text{C}$); DTR: decomposition temperature ($^{\circ}\text{C}$) range; TWL: temperature ($^{\circ}\text{C}$) corresponding to the weight loss (%).

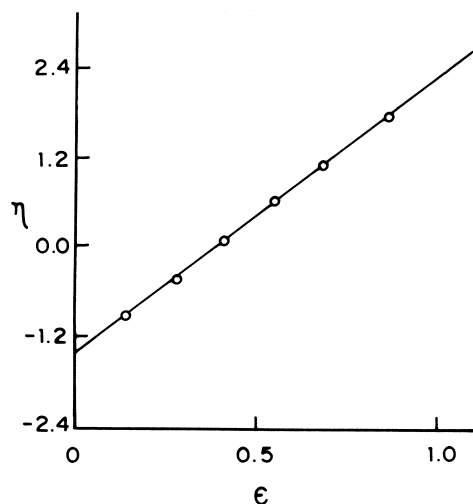

Figure 6. K-T plot for the Determination of Reactivity Ratios of CPMA-GMA Copolymer System.

decomposition of polymer. The first stage decomposition of poly (CPMA) occurs in the temperature range of 272-533°C with a weight loss of about 76%. A weight loss of about 19% occurs in the second stage in the temperature range of 553-659°C. Poly (GMA) undergoes a single stage decomposition at 200-416°C with a concomitant weight loss of about 96%. In the case of copolymers, as the CPMA content in the copolymer increased the weight loss decreased (<40%) in the first stage at 272-533°C and increased (>60%) in the second stage at 553-659°C and the total weight loss was about 98% at 600°C.

Photocrosslinking Properties

The photocrosslinking properties of copolymers have been studied by irradiating the polymer films with a high pressure Hg lamp by measuring the changes in the U.V. absorption intensity at 311 nm due to the pendant cinnamoyl group of poly(CPMA-co-GMA). The changes in the UV spectra (Figure 7) upon irradiation at 311 nm is highly remarkable. An isobestic point at 268 nm appeared during initial irradiation was due to the formation of trans-cis isomerization of the double bond. Further irradiation causes a fast increase in absorption at 311 nm. This behaviour of polymers can be regarded as formation of cyclobutane rings [26] by 2+2 cycloaddition of olefine bonds of pendant chalcone. Since the cyclisation process causes cyclobutane ring formation from the

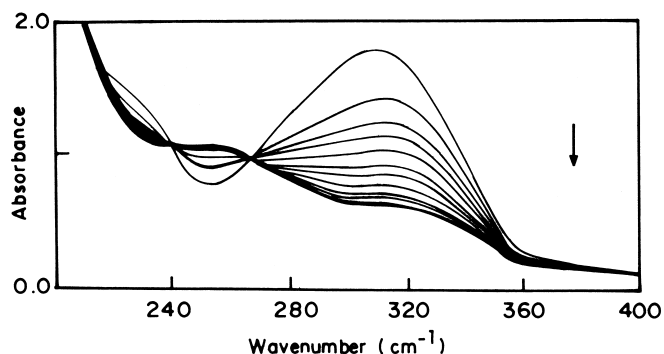

Figure 7. Changes in the Ultraviolet Spectra Upon Irradiation of Poly(CPMA-co-GMA) after 0, .25, 0.5, 1, .5, 1.5, 2.5, 4.5, 6.5, 10, 13, 16, 20, 25 minutes of Irradiation Time.

pendant chalcone unit, it is obvious that this process destroys conjugation in the entire π -electron system. Hence, the intensity of absorption maximum of the chalcone decrease [27]. In the case of poly(CPMA), a photo conversion of about 52% occurs within 30s of irradiation time. By this time polymer was completely insoluble in organic solvents.

In the case of copolymers, a photoconversion rate of 45% occurs after 30s of irradiation showing the highly photocrosslinking nature of cinnamoyl group in CPMA. There is a systematic change in the percentage conversion with the composition of the copolymers. The copolymers are insoluble in many organic solvents like chloroform, dimethylformamide, tetrahydrofuran etc., after 45s of irradiation by which time photocrosslinking has occurred in the case of all the copolymers. The photocrosslinking reactions of the copolymers are faster than that of the homopolymer.

CONCLUSION

Poly(CPMA) and the copolymers of CPMA with GMA were synthesized in solution by free radical polymerization. Copolymers were characterized by UV, IR, $^1\text{H-NMR}$, AND $^{13}\text{C-NMR}$ spectroscopic techniques. The compositions of copolymers were determined by $^1\text{H-NMR}$ analysis. The reactivity ratios r_1 and r_2 were calculated by the application of the conventional linearization methods suggested by Kelen-Tüdös and Fineman-Ross and the values are in good agree-

ment. The r_1 values are greater than 1 and r_2 values are less than 1 and this shows that CPMA is more reactive than GMA. Furthermore, this suggests that the composition of copolymer in respect to CPMA is always higher than that in the feed and that of CPMA is always lower than that in the feed. The polydispersity index (M_w/M_n) values from GPC data of the copolymers suggest a strong tendency for chain termination by disproportionation at high mole fractions of GMA and recombination at high mole fractions of CPMA in the feed. Thermogravimetric analysis results indicate that the copolymers undergo decomposition in two stages and it was observed that as the CPMA content in the copolymer system increased the copolymer weight loss (<40%) decreased in the first stage of decomposition and increased (>60%) in the second stage of decomposition. Finally the photocrosslinking behaviour of the copolymers were tested as thin films in the presence of UV light. Higher photoconversion rate of about 45% was observed for the copolymers thus showing the high photo reactive nature of cinnamoylphenyl group.

REFERENCES

- [1] O.Vogl, A. C. Albertsson, and Z. Janovic, *Polymer*, 26, 1288 (1985).
- [2] G. Nagamatsu and H. Inui. *Photosensitive Polymer*; Kodansha, Tokyo (1977).
- [3] A. Reiser, *Photoreactive Polymers - The Science and Technology of Resists*, Chapt. 2, Wiley, New York, 1989.
- [4] S.Tazuke, *Developments in Polymer Photochemistry*, Vol. 3, Applied Science Publishers, London , 1982.
- [5] V. A. Chese, in *Radome Engineering Handbook*, J. D.Walton, Ed., Dekker, New York, 1970, p. 172.
- [6] L. E. Mathew and L.Patricia, *Polym. Commun.*, 32, 453 (1991).
- [7] L. M. Minsk, J. G. Smith, W. P. Van Deusen, and J. F. Wright., *J. Appl. Polym. Sci.*, 2, 302 (1952).
- [8] T. Nishikubo, T. Iizawa, M. Yamada, and K.Tsuchiya, *J. Polym. Sci. Polym. Chem. Edn.*, 21, 2025 (1983).
- [9] Y. Shindo, H. Sato, T. Sugima, H. Horie, and I. Mita, *Eur. Polym. J.*, 25, 1033 (1989).
- [10] S. Watanabe, M. Kato, and S. Kosaki, *J. Polym. Sci., Polym. Chem. Edn.*, 22, 2801 (1984).

- [11] T. Nishikubo, T. Izawa, E. Takahasi, and N. Fumihiko, *Macromolecules*, **25**, 1033 (1989).
- [12] Y. Yamashita, S. Kyo, T. Miyagawa, M. Nango, and K. Tsuda, *J. Appl. Polym. Sci.*, **52**, 577 (1994).
- [13] M. J. Whitcombe, A. Gilbert, A. Hirai, and G. R. Michales, *J. Polym. Sci., Polym. Chem. Edn.*, **29**, 251 (1991).
- [14] K. Ichimura and Y. Nishio. *J. Polym. Sci., Polym. Chem. Edn.*, **25**, 1579 (1987).
- [15] C. C. Unruh, *J. Appl. Polym. Sci.*, **2**, 358 (1959).
- [16] S. Watanabe, H. Harashima, and N. Tsukada, *J. Polym. Sci., Polym. Chem. Edn.*, **24**, 1227 (1986).
- [17] K. Subramanian, A. V. Rami Reddy, and V. Krishnasamy, *Makromol. Chem. Rapid Commun.*, **12**, 211 (1991).
- [18] G. M. Stampel, R. P. Cross, and R. P. Maliella, *J. Am. Chem. Soc.*, **72**, 2899 (1950).
- [19] F. R. Mayo and F. M. Lewis, *J. Am. Chem. Soc.*, **66**, 1594 (1944).
- [20] M. Fineman and S. D. Ross, *J. Polym. Sci.*, **5**, 259 (1950).
- [21] T. Kelen and F. Tüdös. *J. Macromol. Sci. Chem.*, **A9**, 1 (1975).
- [22] S. Teramachi, A. Hasegava, M. Akatsuka, A. Yamashita, and N. Takemoto, *Macromolecules.*, **11**, 1206 (1978).
- [23] H. W. Melville, B. Noble, and W. F. Watson, *J. Polym. Sci.*, **4**, 629 (1949).
- [24] J. Brandrup and E. H. Immergut, *Polymer Handbook, Second Edn.*, Wiley Interscience, New York.
- [25] C. W. Pyun, *J. Polym. Sci., Part A-2*, **8**, 1111 (1970).
- [26] S. Watanabe and M. Kato, *J. Polym. Sci. Polym. Chem. Edn.*, **22**, 2801 (1984).
- [27] S. Watanabe, S. Harashima, and N. Tsukada, *J. Polym. Sci., Part A, Polym. Chem.*, **24**, 1227 (1986).

Received August 10, 1999

Revision received May 12, 2000